

## IT7000 - High Performance HMI

High-end functionality and connectivity;  
easy integration with any machine control system

- 7", 10" & 15" display sizes
- IP65 rating (front side)
- Built-in Ethernet and serial ports



# The IT7000 – flexible human machine interface



## Functionality

- Supports **VNC** remote access through mobile devices
- Trend chart & oscilloscope for continuous wave sampling
- **Multi-language** capability



## Programming

- User friendly InoTouchPad PC configuration software (Windows 10 compatible)
- **Javascript** for creation of plug-ins and dedicated communication protocols, & access to external databases
- Canvas control for free graphic drawing



## Graphical capabilities

- Up to 1,024 x 768 resolution (16 M colours)
- Customizable user interface (via CSS)



## Data management

- USB & micro SD cards for easy data management
- **Real-time clock**
- Maintains comprehensive historical data records



## Flexible connectivity

- Serial port and/or Ethernet stand-alone and multi-device networking
- Supports products from a wide range of 3rd party manufacturers
- Support for **OPC UA** and **Modbus RTU/TCP** protocols
- IIoT ready: **MQTT** implementation, seamlessly connects to any server



\*Image shown is the 15" model

## IT7070E & IT7100E terminals

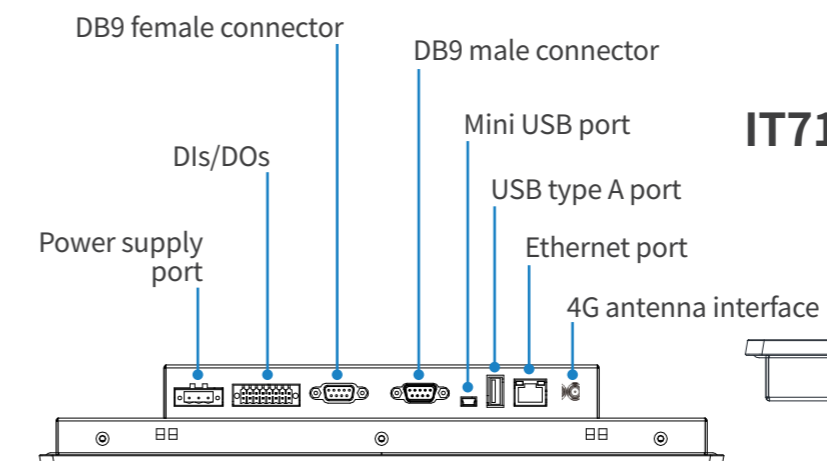
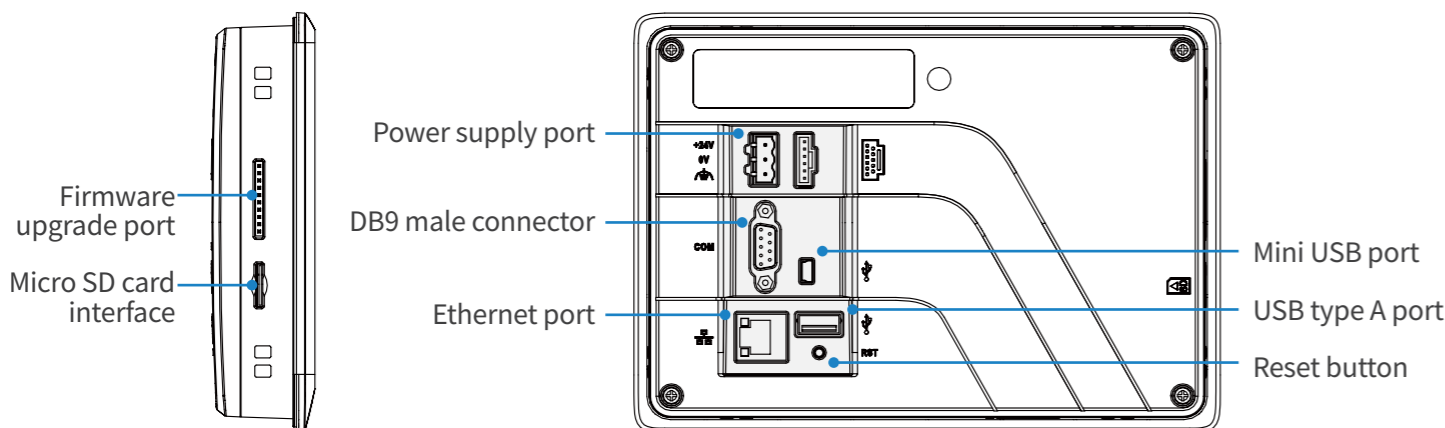

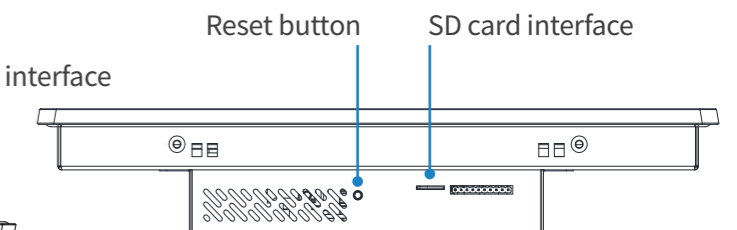

## IT7150E terminals

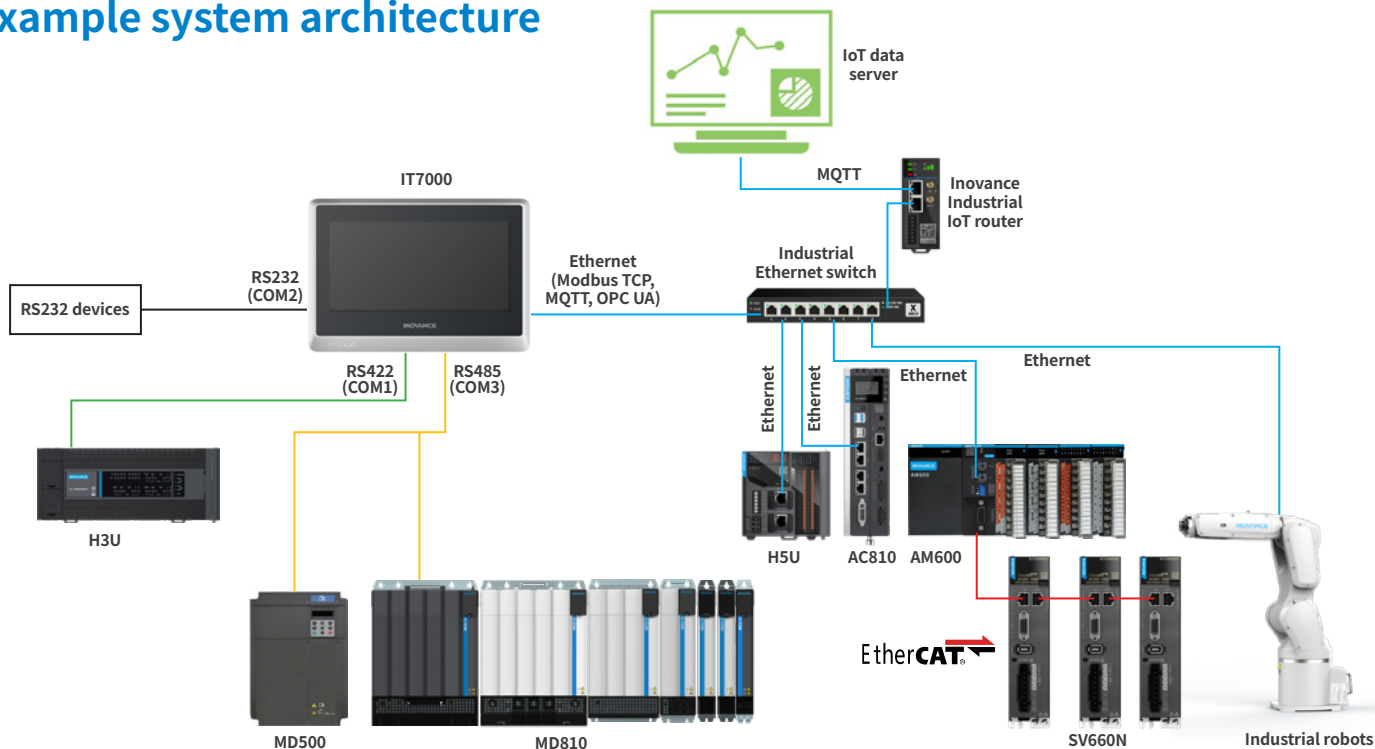

## Example system architecture



## Specifications

Model	IT7070E	IT7100E	IT7150E
			
Display size	7.0"	10.1"	15.0"
Dimensions L x W x D (mm)	200 x 146 x 35	271 x 146 x 36	368 x 295 x 53
Resolution	800 x 480	1,024 x 600	1,024 x 768
CPU	Cortex A8 600 MHz	Cortex A8 1 GHz	Cortex A8 1 GHz
RTC	✓	✓	✓
DRAM	128 MB	256 MB DDR3	256 MB DDR3
Flash	128 MB	256 MB	256 MB
Brightness (cd/m <sup>2</sup> )	350	350	300
Display colour	24-bit true colour		
Backlight	LED		
Backlight service life	35,000 hrs	30,000 hrs	50,000 hrs
SD card interface	✓	✓	✓
USB drive interface	USB 2.0 interface x 1		
USB download interface	Mini USB interface x 1		
Ethernet interface	✓	✓	✓
Serial port	COM1 (RS422/RS485) COM2 (RS232) COM3 (RS485)		
Panel IP rating	Front panel IP65, back cover IP20		
Product code	01450039	01450036	01450028